

Article number: 0101100
 Description: Retaining ring A 105 DIN 471
 Spring steel
 Note: Fitted with ZGA pilers

Measures

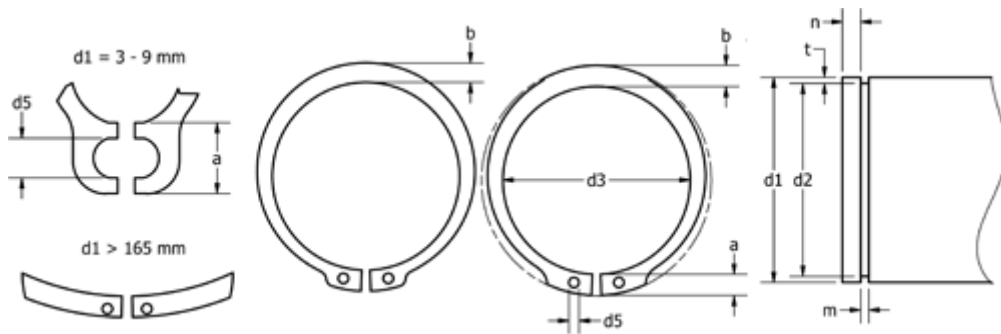

a max	= 9.9	FN kN	= 107.0	s	= 4.00
AN mm ²	= 646.0	FRg kN	= 67.70	t	= 2.00
b	= 9.3	FR kN	= 471.00	tol	= -0.54
d1	= 105	g	= 3.5	tol	= -0.10
d2	= 101.0	K kN-mm	= 925.00	tol	= +0,54-1,30
d3	= 98.0	m min	= 4.15	Tong	= ZGA-4
d5 min	= 3.5	n abl x 1000	= 5.0	Weight kg/1000	= 80.000
Description	= A105	Nominal drive	= 6.0		